

SOLAR 420 LCV

Operating Weight: 41.100 ~ 42.800 kg

Bucket capacity (CECE): 1,44 ~ 2,18 m³

Engine Power: 210 kW (281 Hp) / 2.000 rpm



www.eurodaewoo.com

DAEWOO

Performance

This hydraulic excavator is equipped with the air-to-air intercooler engine, which has the greatest power output in its class and excellent fuel economy. It assures outstanding workability, productivity, and efficiency through the e-EPOS system, the new and improved version of EPOS System. This will assure increase in operating capacity and decrease in fuel consumption.

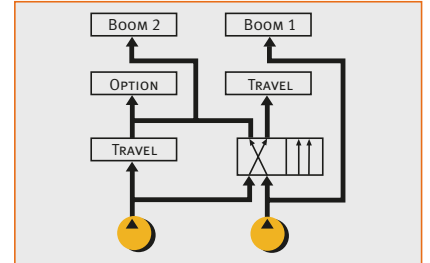
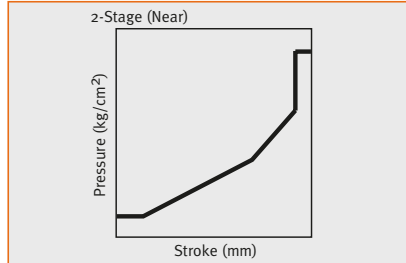

Improved manoeuvrability and control

New technologically advanced control valve and joystick valves have been installed to allow speedy, smooth and responsive control.

Advanced hydraulic circuit separates the oil flow for travel and boom function to allow precise and safe operation when handling loads during travel.

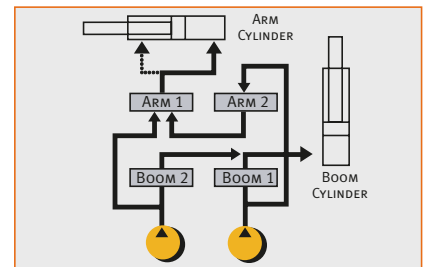

The circuits for the boom, arm, and bucket have been improved to assure smooth and confident control during combination.

Air-to-Air Intercooler Engine

Greatest power output and high-efficiency engine in its class.

Environmentally friendly, Green engine

This machine is equipped with the engine meeting the U.S. EPA Tier-II Regulations and European stage-II.

Joystick grip with 3 switches

Spare switches are installed on both joystick grips to control the additional attachment.

Increased swing force. (Equipped with antirebound valve)

Swing torque has been increased by 14% to improve turning acceleration and deceleration and antirebound valve is installed as standard equipment, which allows the operator to stop the upper structure at the desired position. As a result, operating efficiency has been greatly improved.



Excellent Reliability

Daewoo's world-class center for product reliability performs sophisticated testing on all completed products, to ensure they meet or exceed market standards.



Heat shield panel for turbo charger

The heat shield guard has been installed over the turbo charger to prevent the operator from inadvertently touching the hot surfaces while checking the engine area.



Brushless type alternator

The semi-permanent alternator, resistant to dust and other pollutants for heavy-duty applications has been installed.



Emergency throttle cable

In the event of engine speed control dial malfunction, emergency throttle cable mounted in the cabin can be used to manually control engine speed.

Improved stability

The center of gravity has been lowered and optimized by the strengthened undercarriage and heavier counter weight. These have greatly improved the dynamic stability and side lifting capacity.



360° fan guard

A metal mesh guard has been installed all around the fan blade to prevent accidental bodily injury.



Rubber coated wire harness clamps

Electric wire harnesses have been mounted with rubber coated clamps to decrease vibration damage.

Larger rubber pipe clamps

Larger size and improved material pipe clamps have been installed.

This has resulted in noise reduction, increased vibration absorption and durability characteristics as well as preventing pipe cracks.



Working Environment

Wide operator cabin space meeting the ISO Standards and expanded all-round visibility. The low-noise, low-vibration type comfortable cabin provides the operator with safe and ergonomic operating environment.



Good visibility

The enlarged right-hand glass and the minimized crosswise strut in windshield have been achieved to increase the visual range by 15% when compared to the previous machine.

Increased foot space

Instruments, controls, and accessories have been ergonomically located in the cabin and 300mm seat slide has been achieved to provide ample space for operator's feet and legs.



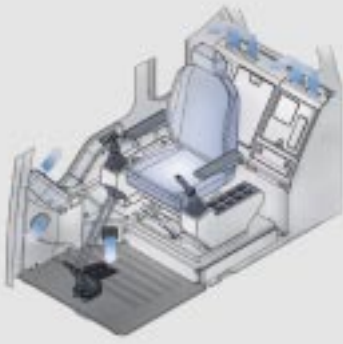

Fresh Air Type Air Conditioner

One touch selector switch for the air conditioner and heater output, featuring a multivent circulation system that allows for greater cooling / heating performance. Improved front window defroster system has been added to provide enhanced clarity and visibility during any working condition.

- Easy replaceable air filter
- Larger cool air intake vents
- Industry standard fresh air/recirculation control system incorporated
- Modular electric fan condenser compartment



Cup holder

A folding style cup holder has been installed in the cabin allowing the operator to easily store a can or cup.



12 V Spare Power Socket

This socket can be used for charging a cellular phone or powering a small 12V DC electrical device.

Low Vibration Cab Mounting System

By using a total isolating seal design (full sealing) outside noise has been drastically reduced to the levels comparable to that in a modern car. A viscous sealed mounting system has been incorporated, and the frame, cabin and seat have been designed to absorb major and minor vibrations, resulting in a significant decrease in vibration felt by the operator.

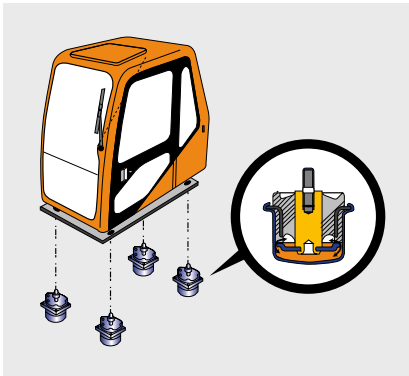

Long wind shield wiper blade

Front visibility is further improved by using the lengthened wiper blade.

Large ceiling cover

The ceiling cover can be opened to confirm the bucket operation even at the maximum excavating height.



Maintenance

Quick and easy service checks, maximizing the excavator's life expectancy.



Engine oil drain valve

The engine oil drain valve with quick coupler provides fast and environmentally sound serviceability.



Electrical control access box

Pull-out style drawer for electrical control access box allows for easy service and maintenance.



PC monitoring function (SMS)

By connecting a laptop PC to the controller (e-EPOS controller) of the machine, data such as pump pressure and engine RPM can be displayed graphically. Also other various machine status data can be stored in memory and printed out using a printer.



Easy installation for the 3rd pump

The PTO mountable pump has been installed permitting easy mounting of the 3rd pump.

Easy radiator cleaning

The clearance between the oil cooler and radiator has been widened for easy insertion of the air nozzle during cleaning.

Water separator

The transparent glass water separator is mounted at a location easily accessible from the ground allowing easy maintenance of the fuel system.

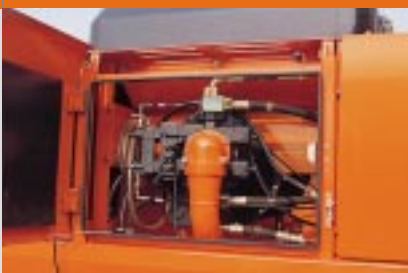
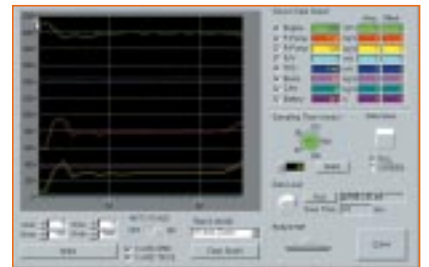

GRAPHIC DISPLAY LCD MONITOR PANEL

The information monitor panel displays both text and symbols for easy recognition of machine status and various other data.

SIMPLIFIED OPERATION MODE SELECTION

The 3 work modes from the previous models have been reduced to digging and trenching modes for easy selection.

Digging Mode :

General Excavating, Ground Leveling, Loading Dump Truck, allows for versatility.

Trenching Mode :

trenching or excavating of side wall, operations which require heavy swing work.

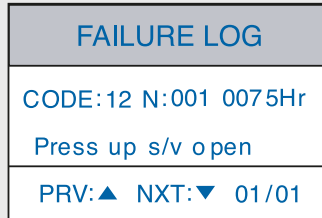

Self-diagnosis and fault history memory functions

Current faults and past faults history of the excavator control system are displayed and memorized on a real-time basis to enable correct diagnosis and quick repair.



Real-time clock with day / date

The real-time clock displays date and day in easy to read format.



Filter / oil operating hour display

The hours in use for 9 filters and oils can be displayed so that replacement intervals can be easily recognized.

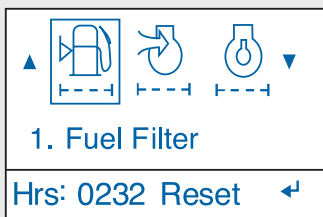

Multiple language display

The user menu can be displayed in multiple languages for the operator's convenience.

Real-time machine data display

Displays 28 different machine status data and information such as pump delivery pressure and engine RPM.

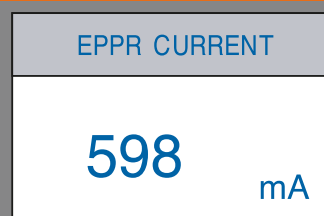

Technical Data

* ENGINE

MODEL

DAEWOO DE12TIS

TYPE

Water-cooled, 4-cycle, direct injection

ASPIRATION

Turbocharged – Air-to-Air intercooler

NUMBER OF CYLINDERS

6

RATED FLYWHEEL HORSE POWER

DIN 6271, net 210 kW (285 Ps)
at 2.000 rpm
SAE J1349, net 210 kW (281 Hp)
at 2.000 rpm

PISTON DISPLACEMENT

11.051 cc

MAXIMUM TORQUE

118 kgf.m (1.203 Nm) at 1.400 rpm

BORE AND STROKE

123 x 155 mm

STARTING SYSTEM

24 V electric motor

BATTERIES

2 x 12 V x 150 Ah

N HYDRAULIC SYSTEM

e-EPOS (Electronic Power Optimizing System) allows the operator to maximize work efficiency over a full range of operating conditions and to minimize fuel consumption.

- Hydraulic system assures fully independent and combined operations.
- Automatic 2 speed travel system for high traction force and travel speed.
- Cross-sensing and fuel saving pump system.
- Auto idle system.
- 2-Working /2-power mode selection system.
- Computer aided engine-pump control.

MAIN PUMPS

2 variable displacement axial piston pumps.

Max. oil flow 2 x 315 l/min

PILOT PUMP

Gear pump

Max. oil flow 24 l/min

SWING MOTOR

Relief valve 265 bar

MAIN RELIEF VALVES

Boom/Arm/Bucket

– Normal 324 bar

– Power Boost 343 bar

Travel circuit 324 bar

H HYDRAULIC CYLINDERS

High-strength piston rods and tubes are used. Cylinder cushion mechanism is provided for all cylinders to assure shock-free operation and extend life of cylinder.

Cylinders	Q'ty	Bore x Rod dia. x Stroke
Boom	2	165 x 115 x 1.460 mm
Arm	1	180 x 120 x 1.820 mm
Bucket	1	160 x 110 x 1.300 mm

SUPER-STRUCTURE REVOLVING FRAME

A deep, full-reinforced box section. Heavy-gauge steel plates used for ruggedness.

2 TRAVEL PEDALS WITH LEVERS

Pilot pressure control type. Independent drive at each track allows counter-rotation of the tracks. Levers are detachable.

CONTROLS 2 IMPLEMENT LEVERS

Pilot pressure control type. Right lever is boom and bucket control, left lever for swing and arm control.

OPERATOR'S CAB

A roomy, independent, shock and noise-free operator's cab, 4 side safety glass windows give all-round visibility. Front window slides up and stores in the roof and side window can be opened for ventilation. Fully adjustable suspension seat. Air conditioner. ISO standard cab.

NOISE LEVELS (DYNAMIC VALUE)

LwA external noise:

– Guaranteed Sound Power Level
108 dB (A) (2000/14/EC)

– Measured Sound Power Level
107 dB (A) (2000/14/EC)

LpA operator noise:

73 dB (A) (ISO6396)

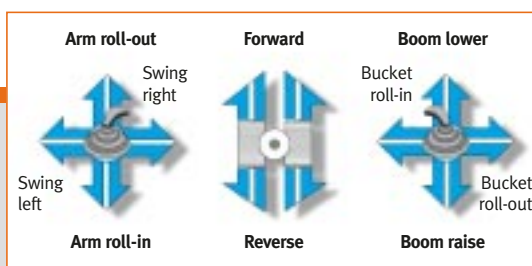



SWING MECHANISM

High-torque, axial piston motor with planetary reduction gear bathed in oil. Swing circle is singlerow, shear type ball bearing with induction-hardened internal gear. Internal gear and pinion gear immersed in lubricant. Swing parking brake is spring-set, hydraulic-released disc type. A two position swing lock secures the super-structure for transportation.

SWING SPEED

0 to 9,5 rpm

REAR SWING RADIUS

3.660 mm



DRIVE

Each track is driven by an independent, high-torque, axial piston motor through planetary reduction gear. Two levers or foot pedal control provide smooth travel or counter-rotation upon demand.

TRAVEL SPEED

5,5/3,3 km/h

MAXIMUM TRACTIVE FORCE

Force 33.400 kgf

Gradeability 35° (70%) continuous



UNDERCARRIAGE

Tractor type undercarriage. Heavy-duty track frame, all welded stress-relieved structure. Top grade materials are used for toughness. Side frames are welded, securely and rigidly, to the track frame.

Lifetime-lubricated track rollers, idlers and sprockets with floating seals. Track shoes of induction-hardened rolled alloy with triple grousers. Specially heat-treated connecting pins. Hydraulic track adjusters with shock-absorbing recoil springs.

NUMBER OF ROLLERS AND SHOES

(EACH SIDE) GROUND CONTACT AREA

Upper rollers 2

(STANDARD SHOE)

Lower rollers 9

Track shoes 50

Overall track length 5.215 mm



BRAKE

Two oil disc brake on final drive input shafts. Parking brake is spring-set, hydraulic-released disc type.



WEIGHT

Equipped with 6,7 m boom, 3,25 m arm, and 1,9 m³ (SAE heaped) bucket and 600 mm shoes.

SHOE TYPE	Shoe Width	Operating weight	Ground pressure
Triple grouser	600 mm	41.200 kg	0,73 kgf/cm ²
	750 mm	41.900 kg	0,59 kgf/cm ²
	800 mm	42.100 kg	0,56 kgf/cm ²
	900 mm	42.600 kg	0,50 kgf/cm ²



SERVICE REFILL CAPACITIES (liters)

Fuel tank 550
Cooling system 56

LUBRICATION

Engine oil 28
Swing drive (each) 6
Final drive (each) 6,8
Hydraulic system 410
Hydraulic tank 265



BUCKETS

CAPACITY		WIDTH		WEIGHT	RECOMMENDATION		
SAE, heaped	CECE, heaped	Without side cutters	With side cutters		2,6 m Arm	3,2 m Arm	4,0 m Arm
1,44 m ³	1,3 m ³	1.192 mm	1.266 mm	1.550 kg	A	A	A
1,68 m ³	1,5 m ³	1.348 mm	1.422 mm	1.605 kg	A	A	B
1,9 m ³	1,7 m ³	1.466 mm	1.540 mm	1.650 kg	A	B	B
2,18 m ³	1,9 m ³	1.634 mm	1.705 mm	1.720 kg	B	B	C

A. Suitable for materials with density of 2.000 kg/m³ or less

B. Suitable for materials with density of 1.600 kg/m³ or less

C. Suitable for materials with density of 1.100 kg/m³ or less

Dimensions & Working Ranges

DIMENSIONS

A	Overall width of upper structure	2.990 mm
B	Overall width of cab	960 mm
C	Overall height of cab	3.150 mm
D	Tail swing radius	3.660 mm
E	Overall height of boom	
	Arm length (3,25 m)	3.575 mm
	Arm length (4,0 m)	3.780 mm
	Arm length (4,0 m)	4.040 mm
F	Clearance under counterweight	1.277 mm
G	Ground clearance	540 mm
H	Tumbler distance	4.250 mm
I	Track length	5.215 mm
J	Track gauge	2.750 mm
K	Track shoe width	600 mm
L	Overall length	
	Arm length (3,25 m)	11.690 mm
	Arm length (2,6 m)	11.780 mm
	Arm length (4,0 m)	11.790 mm
M	Overall track width	3.350 mm

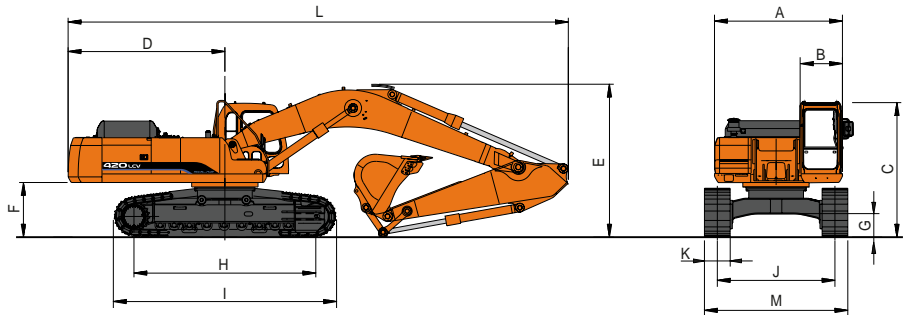

WORKING RANGES

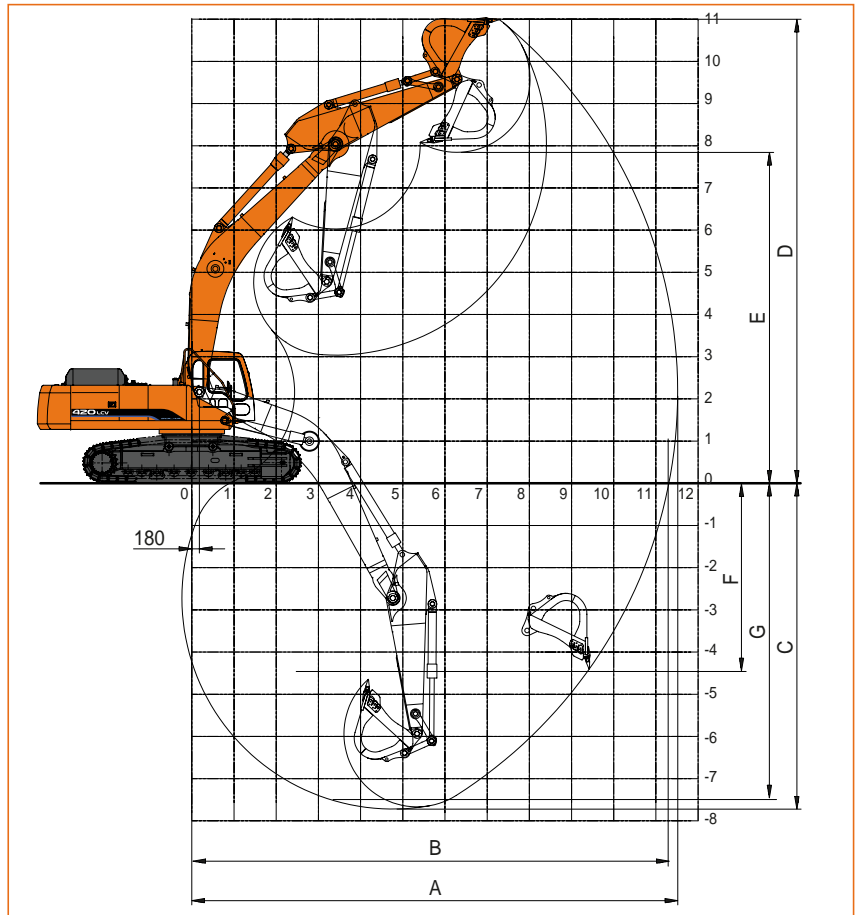

DIGGING FORCES (ISO)

		3,25 m	2,6 m	4,0 m
Bucket digging force *	kgf	27.000	27.000	27.000
	kN	265	265	265
Arm digging force *	kgf	19.700	19.700	19.700
	kN	193	233	168

* At power boost

Boom length (6,7 m)

Bucket (m³ SAE)	1,9 m³	2,18 m³	1,68 m³
Arm length	3.250 mm	2.600 mm	4.000 mm

A. Max. digging reach	11.520 mm	10.910 mm	12.260 mm
B. Max. digging reach at ground level	11.310 mm	10.700 mm	12.070 mm
C. Max. digging depth	7.725 mm	7.070 mm	8.470 mm
D. Max. digging height	11.000 mm	10.660 mm	11.495 mm
E. Max. dumping height	7.845 mm	7.555 mm	8.330 mm
F. Max. vertical wall digging depth	4.400 mm	3.490 mm	5.065 mm
G. Max. digging depth (2,44 m level)	7.570 mm	6.900 mm	8.360 mm

Lifting Capacities

STANDARD

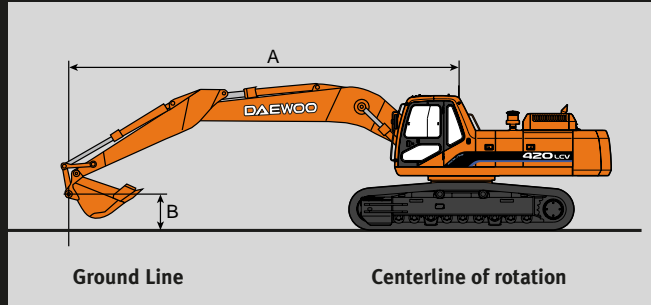

A(m)	2		3		4		5		6		7		8		9		Max. Reach					
B(m)	⏏	⏏	⏏	⏏	⏏	⏏	⏏	⏏	⏏	⏏	⏏	⏏	⏏	⏏	⏏	⏏	⏏	⏏	⏏	A(m)		
Boom : 6,7 m — Arm : 3,25 m — Bucket : SAE 1,9 m³ (CECE 1,7 m³) — Shoe : 600 mm																						
9																				*7,17	*7,17	7,13
8																				*7,06	*7,06	7,99
7																				*7,10	6,51	8,65
6												*8,16	*8,16	*7,63	7,52				*7,23	5,82	9,15	
5																				*7,94	5,94	9,52
4																				*8,85	7,13	9,77
3																				*8,65	5,71	9,91
2																				*10,02	6,77	9,95
1																				8,96	5,6	9,95
0																				*14,97	*14,97	9,88
-1																				*15,91	*15,91	9,71
-2																				*18,55	*18,55	9,43
-3																				*19,75	*19,75	9,49
-4																				*24,77	*24,77	9,78
-5																				*21,19	*21,19	6,85
-6																				*16,27	*16,27	5,58

OPTION

A(m)	2		3		4		5		6		7		8		9		Max. Reach					
B(m)	⏏	⏏	⏏	⏏	⏏	⏏	⏏	⏏	⏏	⏏	⏏	⏏	⏏	⏏	⏏	⏏	⏏	⏏	⏏	⏏	A(m)	
Boom : 6,7 m — Arm : 2,6 m — Bucket : SAE 2,15 m³ (CECE 1,9 m³) — Shoe : 600 mm																						
8																						7,06
7																						7,8
6																						8,36
5																						8,76
4																						9,03
3																						9,18
2																						9,22
1																						9,15
0																						8,96
-1																						8,66
-2																						8,22
-3																						7,62
-4																						6,82
-5																						5,73

A(m)	2		3		4		5		6		7		8		9		10		Max. Reach			
B(m)	⏏	⏏	⏏	⏏	⏏	⏏	⏏	⏏	⏏	⏏	⏏	⏏	⏏	⏏	⏏	⏏	⏏	⏏	⏏	⏏	A(m)	
Boom : 6,7 m — Arm : 4,0 m — Bucket : SAE 1,44 m³ (CECE 1,3 m³) — Shoe : 600 mm																						
9																						8,1
8																						8,87
7																						9,46
6																						9,92
5																						10,26
4																						10,49
3																						10,62
2																						10,66
1																						10,6
0																						10,44
-1																						10,18
-2																						9,81
-3																						9,31
-4																						8,67
-5																						7,85
-6																						6,78
-7																						5,31

Note 1. Ratings are based on SAE J1097
 2. Load point is the hook on the back of the bucket
 3. * = Rated loads are based on hydraulic capacity
 4. Rated loads do not exceed 87% of hydraulic capacity or 75% of tipping capacity

⏏ : Rating over front
 ⏏ : Rating over side or 360 degree
 ○ : Ground

OPTION

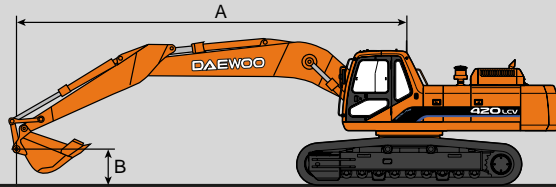

Ground Line

Centerline of rotation

A(m)	2		3		4		5		6		7		8		9		Max. Reach			
																			A(m)	
Boom : 6,7 m — Arm : 3,25 m — Bucket : SAE 1,9 m³ (CECE 1,7 m³) — Shoe : 800 mm																				
B(m)																				
9																				*7,17 *7,17 7,13
8																				*7,06 *7,06 7,99
7														*7,63 *7,63						*7,10 6,65 8,65
6														*8,16 *8,16						*7,88 7,59 *7,73 6,15 *7,23 5,95 9,15
5																				*9,63 *9,63 *8,85 *8,85 *8,31 7,45 *7,94 6,07 *7,46 5,48 9,52
4																				*19,63 *19,63 *14,88 14,78 *12,24 11,15 *10,57 8,78 *9,45 7,10 *8,65 5,85 7,92 4,95 9,91
3																				*17,95 *17,95 *16,71 14,16 *13,46 10,76 *11,41 8,52 *10,02 6,92 *9,02 5,73 *7,80 4,85 9,95
2																				*14,97 *14,97 *18,00 13,71 *14,43 10,44 *12,11 8,29 *10,51 6,77 *9,05 5,63 *7,81 4,84 9,88
1																				*8,22 *8,22 *15,91 *15,91 *18,68 13,44 *15,06 10,22 *12,60 8,12 *10,77 6,65 *8,97 5,55 *7,97 4,92 9,71
0																				*11,73 *11,73 *18,55 *18,55 *18,81 13,31 *15,30 10,09 *12,82 8,02 *10,68 6,57 *8,91 5,50 *8,31 5,12 9,43
-1	*8,72	*8,72	*11,73	*11,73	*18,55	*18,55	*18,81	13,31	*15,30	10,09	*12,82	8,02	*10,68	6,57	*8,91	5,50	*8,31	5,12	9,43	
-2	*12,34	*12,34	*15,51	*15,51	*22,33	19,16	*18,46	13,28	*15,17	10,03	*12,73	7,97	*10,65	6,54	*8,91	5,50	*8,87	5,47	9,03	
-3	*16,08	*16,08	*19,75	*19,75	*21,73	19,30	*17,65	13,34	*14,61	10,06	*12,28	7,98	*10,37	6,56			*9,50	6,03	8,49	
-4	*20,22	*20,22	*24,77	*24,77	*19,86	19,52	*16,30	13,48	*13,56	10,16	*11,32	8,07					*9,73	6,93	7,78	
-5	*25,04	*25,04	*21,19	*21,19	*17,24	*17,24	*14,26	13,71	*11,80	10,34							*9,88	8,52	6,85	
-6			*16,27	*16,27	*13,49	*13,49	*11,09	*11,09									*9,73	*9,73	5,58	

A(m)	2		3		4		5		6		7		8		9		Max. Reach			
Boom : 6,7 m — Arm : 2,6 m — Bucket : SAE 2,15 m³ (CECE 1,9 m³) — Shoe : 800 mm																				
B(m)																				
8																				*8,51 *8,51 7,06
7																				*8,46 7,72 7,80
6																				*8,50 6,77 8,36
5																				*10,65 *10,65 *9,62 9,01 *8,93 7,20 *8,59 6,15 8,76
4																				*12,26 *12,26 *9,60 *9,60 *8,97 *8,97 *8,58 7,32 *8,50 6,77 8,36
3																				*18,76 *18,76 *14,29 *14,29 *11,88 11,21 *10,39 8,77 *9,40 7,06 *8,74 5,77 *8,73 5,74 9,03
2																				*16,27 14,31 *13,13 10,83 *11,20 8,53 *9,91 6,90 *9,02 5,68 *8,81 5,49 9,18
1																				*17,80 13,82 *14,19 10,50 *11,92 8,31 *10,39 6,76 *9,01 5,59 *8,66 5,37 9,22
0																				*18,64 13,52 *14,92 10,26 *12,47 8,14 *10,75 6,63 *8,93 5,51 *8,70 5,37 9,15
-1																				*14,84 *14,84 *18,86 13,37 *15,28 10,11 *12,77 8,02 *10,66 6,55 *8,93 5,50 8,96
-2	*14,92	*14,92	*18,19	*18,19	*21,73	19,42	*17,85	13,36	*14,80	10,05	*12,42	7,95	*10,48	6,52			*9,40	5,78	8,66	
-3	*20,29	*20,29	*24,18	*24,18	*20,05	19,59	*16,64	13,47	*13,89	10,12	*11,61	8,01					*10,32	7,08	7,62	
-4	*25,74	*25,74	*21,21	*21,21	*17,73	*17,73	*14,83	13,65	*12,36	10,26							*10,48	8,48	6,82	
-5			*17,04	*17,04	*14,46	*14,46	*12,09	*12,09									*10,38	*10,38	5,73	

A(m)	2		3		4		5		6		7		8		9		10		Max. Reach		
Boom : 6,7 m — Arm : 4,0 m — Bucket : SAE 1,44 m³ (CECE 1,3 m³) — Shoe : 800 mm																					
B(m)																					
9																				*5,78 *5,78 8,10	
8																				*6,60 *6,60 *5,67 *5,67 8,87	
7																				*6,69 *6,69 *6,79 6,25 *5,66 *5,66 9,46	
6																				*7,01 *7,01 *6,93 6,19 *5,73 5,14 9,92	
5																				*7,86 *7,86 *7,49 7,48 *7,22 6,09 *7,04 5,01 *5,86 4,77 10,26	
4																				*9,68 *9,68 *8,75 *8,75 *8,09 7,30 *7,62 5,97 *7,29 4,94 *6,06 4,51 10,49	
3																				*11,12 *11,12 *9,72 8,83 *8,76 7,11 *8,07 5,84 *7,56 4,85 *6,34 4,34 10,62	
2																				*7,41 *7,41 *20,48 *20,48 *15,42 14,43 *12,52 10,88 *10,68 8,56 *9,42 6,92 *8,52 5,70 *7,68 4,76 *6,70 4,25 10,66	
1																				*6,70 *6,70 *17,83 *17,83 *17,09 13,92 *13,71 10,53 *11,52 8,31 *10,02 6,75 *8,93 5,58 *7,60 4,68 *6,91 4,24 10,60	
0	*4,38	*4,38	*8,22	*8,22	*16,37	*16,37	*18,19	13,35	*14,58	10,26	*12,18	8,12	*10,49	6,60	8,90	5,48	*7,53	4,62	*7,03 4,30 10,44		
-1	*7,25	*7,25	*10,57	*10,57	*17,54	*17,54	*18,72	13,35	*15,09	10,08	*12,60	7,97	*10,61	6,50	8,82	5,41	*7,48	4,57	*7,28 4,45 10,18		
-2	*10,13	*10,13	*13,42	*13,42	*20,10	19,15	*18,73	13,25	*15,22	9,98	*12,72	7,89	*10,54	6,44	*8,77	5,37			*7,69 4,70 9,81		
-3	*13,22	*13,22	*16,79	*16,79	*22,92	19,20	*18,25	13,25	*14,96	9,95	*12,52	7,86	*10,52	6,42	*8,78	5,37			*8,34 5,11 9,31		
-4	*16,66	*16,66	*20,81	*20,81	*21,45	19,33	*17,28	13,31	*14,25	9,99	*11,92	7,89	*10,00	6,46					*8,79 5,74 8,67		
-5	*20,65	*20,65	*24,54	*24,54	*19,31	*19,31	*15,71	13,46	*12,98	10,10	*10,75	7,99							*8,99 6,76 7,85		
-6	*25,53	*25,53	*20,36	*20,36	*16,28	*16,28	*13,31	*13,31	*10,86	10,31									*9,06 8,59 6,78		
-7					*11,85	*11,85	*9,48	*9,48												*8,75 *8,75 5,31	

Note 1. Ratings are based on SAE J1097
 2. Load point is the hook on the back of the bucket
 3. * = Rated loads are based on hydraulic capacity
 4. Rated loads do not exceed 87% of hydraulic capacity or 75% of tipping capacity

: Rating over front
 : Rating over side or 360 degree
 : Ground

Standard & Optional Equipment

STANDARD EQUIPMENT

HYDRAULIC SYSTEM

- Boom and arm flow regeneration
- Boom and arm holding valves
- Swing anti-rebound valves
- Spare ports (valve)
- One-touch power boost
- Piping for hammer (one way)

CABIN & INTERIOR

- Viscous cab mounts
- All weather sound suppressed type cab
- Air conditioner
- Adjustable suspension seat with head rest and adjustable arm rest
- Pull-up type front window and removable lower front window
- Room light
- Intermittent windshield wiper
- Cigarette lighter and ashtray
- Cup holder
- Hot & cool box
- Graphic display monitor
- Fuel control dial
- AM/FM Radio and cassette player
- Remote radio ON/OFF switch
- 12V spare power socket
- Serial communication port for laptop PC interface
- Joystick lever with 3 switches

SAFETY

- Large handrails and step
- Punched metal anti-slip plates
- Seat belt
- Hydraulic safety lock lever
- Safety glass
- Hammer for emergency escape
- Right and left rearview mirrors
- Boom and arm hose rupture protection valve

OTHERS

- Double element air cleaner
- Pre-cleaner
- Water separator
- Dust screen for radiator
- Engine overheat prevention system
- Engine restart prevention system
- Self-diagnostic system
- Alternator (24 V, 50 A)
- Electric horn
- Halogen working lights (frame mounted 2, boom mounted 2)
- Electric fuel supply pump
- Hydraulic track adjuster
- Track guards

OPTIONAL EQUIPMENT

SAFETY

- Overload warning device
- Cabin Top/Front guard (FOGS standard)
- Travel alarm
- Travel & swing alarm
- Rotating beacon

CABIN & INTERIOR

- Sunvisor
- Sun roof

OTHERS

- Piping for rotation
- Double fuel filter
- Additional work lights on the cabin
 - 2 front lamps
 - 4 front and 2 rear lamps
- Large capacity alternator (24 V, 80 A)

Boom and arm hose rupture protection valve



Sunvisor



Additional work lights on the cabin



Electric fuel supply pump



Rotating beacon



SOLAR 420 LCV

Seoul Office

9th Floor, Daewoo Heavy Industries & Machinery Ltd. Bldg.
14-34, Youido-dong, Youngdungpo-gu
150-010, Seoul Korea
Mail: C. P. O Box 7955 Seoul, Korea
Tel. +82 2 2167-3114 Fax +82 2 785-2677
Website: www.dhiltltd. co. kr

Euro Daewoo S. A.

1A Rue Achille Degrâce,
7080 Frameries, Belgium
Tel. +32 65 61 32 30 Fax +32 65 67 73 38

Euro Daewoo France

2/4, Rue Pavlov, Z.I. des Bruyères
78190 Trappes, France
Tel. +33 1 30 16 21 41 Fax +33 1 30 16 21 44

Euro Daewoo UK

Daewoo House Unit 6.3 Nantgarw Park Cardiff
CF4 7QU, U.K.
Tel. +44 1443 842273 Fax +44 1443 841933

Daewoo Maschinen Vertriebs GmbH

Hans-Böckler-Str. 27-29
40764 Langenfeld, Germany
Tel. +49 2173 8509 18 Fax +49 2173 8509 40
Website: www.daewoomaschinen.de



The illustrations do not necessarily show the product in standard version. All products and equipments are not available in all markets.
Materials and specifications are subjects to change without prior notice.

S420LCV_UK_02/05 • Design by Size Communication (Belgium)

www.eurodaewoo.com

DAEWOO